

Programa productivo, tecnológico y social

Construcción de dispositivos
para las personas con discapacidad



BASTÓN

Manual de fabricación

PLANOS CONSTRUCTIVOS | MANUAL DE ENSAMBLE | LISTADO DE PIEZAS | COSTOS





INTERPRETACION DE CODIGO

EN CUANTO A LOS CODIGOS UTILIZADOS PARA LAS PARTES DE LOS PRODUCTOS, DEBERAN INTERPRETARSE DE LA SIGUIENTE MANERA:

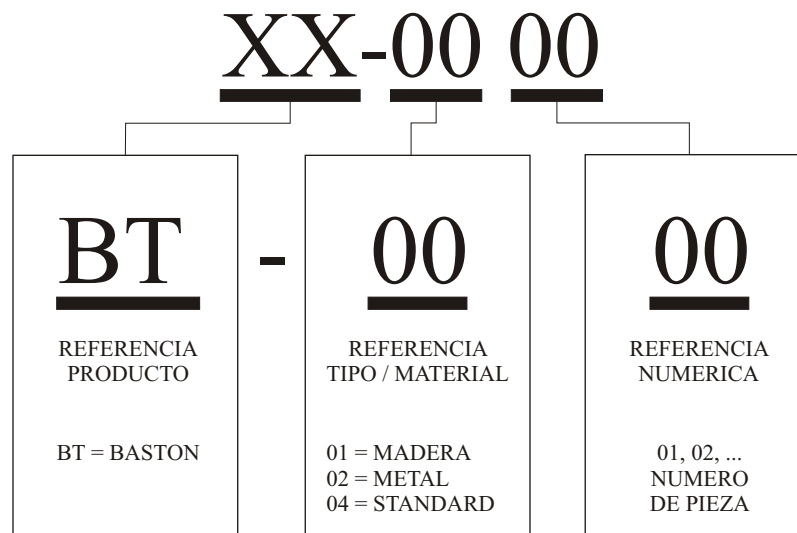

LISTADO DE COMPONENTES FABRICADOS

PIEZA	DESCRIPCION	CANTIDAD	CODIGO
2	Virola	1	BA-02 02
3	Palo de madera torneado	1	BA-02 03

LISTADO DE COMPONENTES STANDARD O PEDIDOS A PROVEEDOR

PIEZA	DESCRIPCION	CANTIDAD	CODIGO
1	Virola	1	BA-02 02
4	Regaton de goma	1	BA-04 01

LISTADO DE COMPONENTES Y CODIFICACION

PIEZA	DESCRIPCION	CANTIDAD	CODIGO
1	Mango madera guatambu	1	BA-02 01
2	Virola	1	BA-02 02
3	Palo de madera torneado	1	BA-02 03
4	Regatón de caucho	1	BA-04 01

PLANOS CONSTRUCTIVOS



ELABORADO POR EL CENTRO DE TECNOLOGIAS PARA LA DISCAPACIDAD INTI

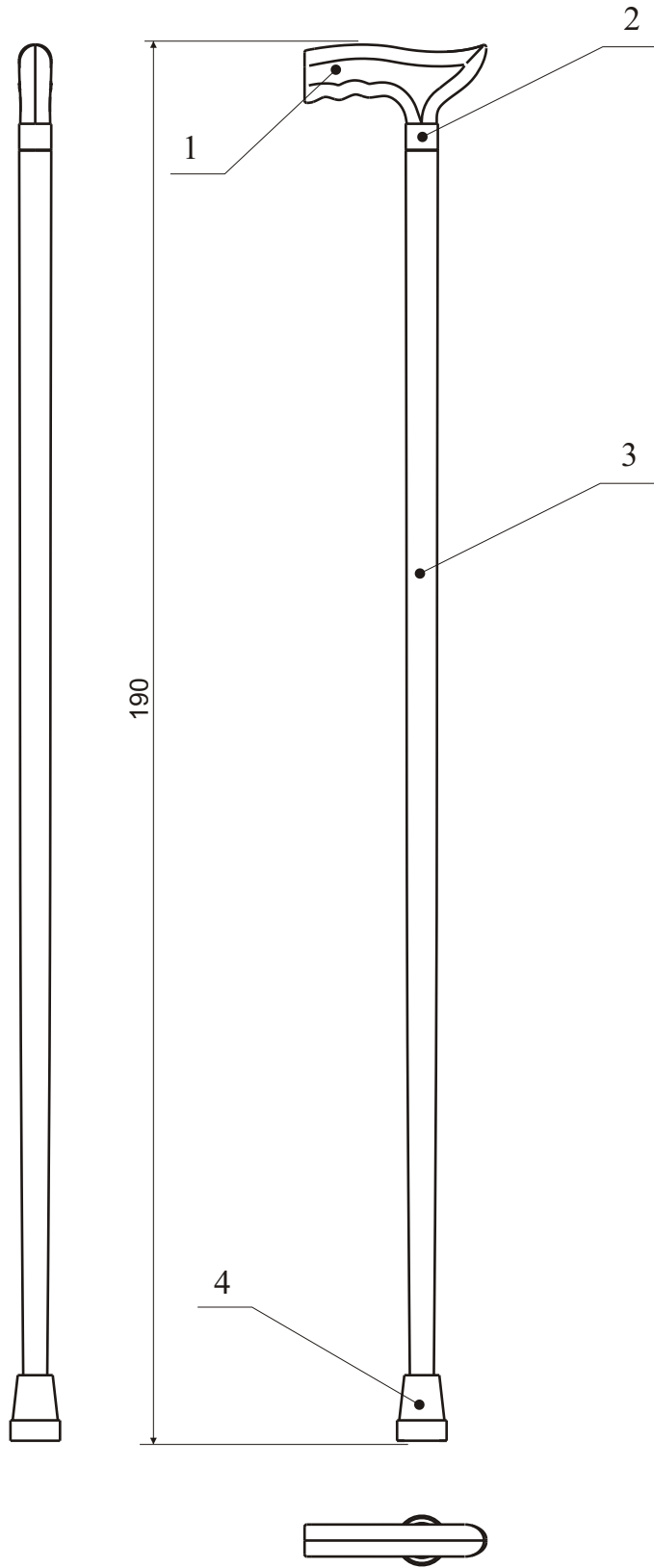

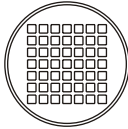
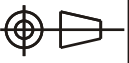
		FECHA	NOMBRE	BASTON	 INTI-INET
	DIBUJO	2007			
	REVISO				
	APROBO				
	ESC. 1:5	LAYOUT			
					
	TOLERANCIA				

PIEZA	DESCRIPCION	CANTIDAD	CODIGO
1	Mango madera guatambu	1	BA-02 01
2	Virola	1	BA-02 02
3	Palo de madera torneado	1	BA-02 03
4	Regatón de caucho	1	BA-04 01

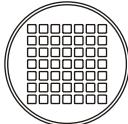
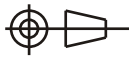
		FECHA	NOMBRE	BASTON	
	DIBUJO	2007			
	REVISO				
	APROBO				
	REFERENCIAS DE LAYOUT				
 TOLERANCIA					

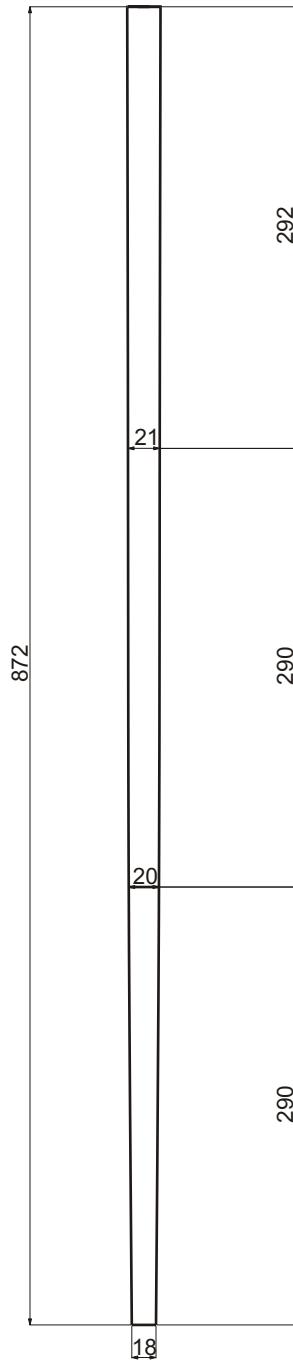

CAÑO 1"1/4 ESP.: 1,5 MM DOBLADO CORTE		FECHA	NOMBRE	BASTON	 INTI-INET CANTIDAD: 1 BT-01 01
	DIBUJO	2007			
	REVISO				
	APROBO				
	ESC. 1:5	PALO DE MADERA TONEADO			
					
TOLERANCIA					

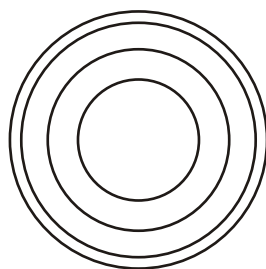
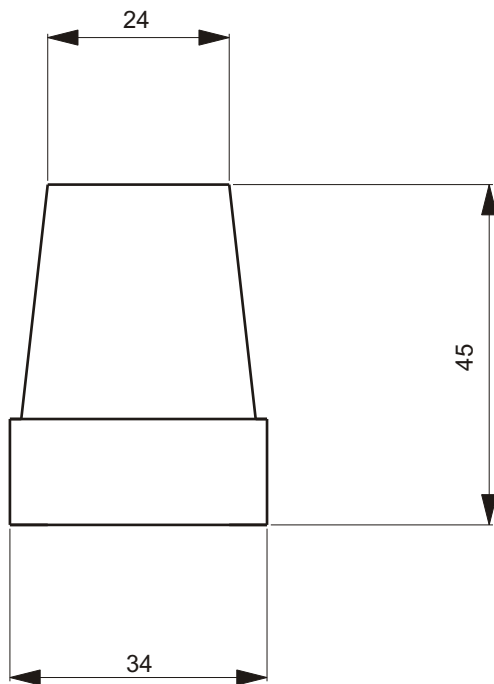

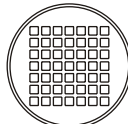
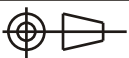
CAÑO 1"1/4 ESP.: 1,5 MM DOBLADO CORTE AGUJEREADO		FECHA	NOMBRE	BASTON	 INTI-INET CANTIDAD: 1 BT-04 02
	DIBUJO	2007			
	REVISO				
	APROBO				
	ESC. 1:1	REGATON DE CAUCHO			
					
TOLERANCIA					

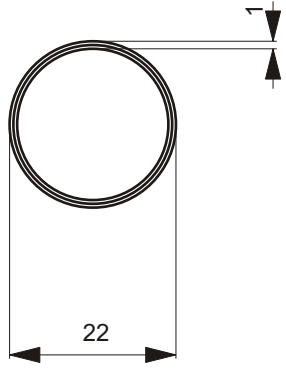
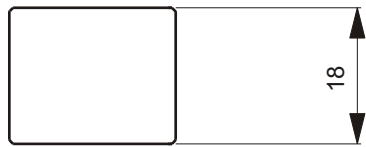

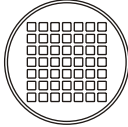
ESP.: 1 MM		FECHA	NOMBRE	BASTON	
	DIBUJO	2007			
	REVISO				
	APROBO				
	ESC. 1:1	COLLARIN DE BRONCE			INTI-INET
					CANTIDAD: 1
	TOLERANCIA				BT-02 01

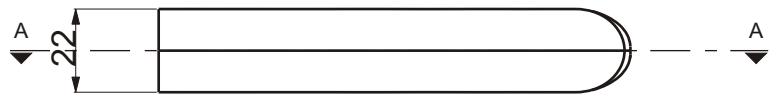
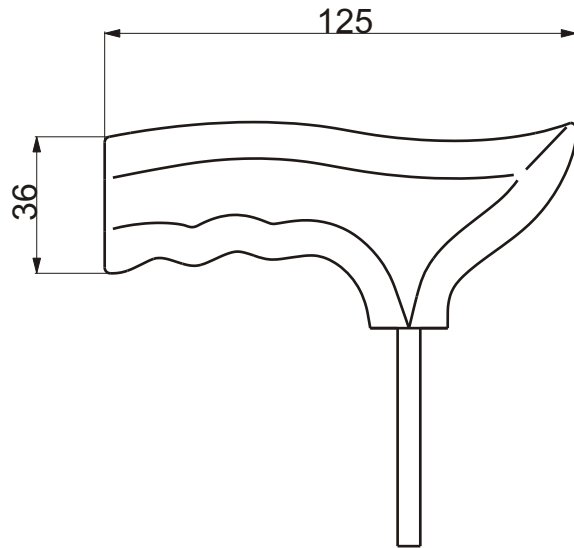
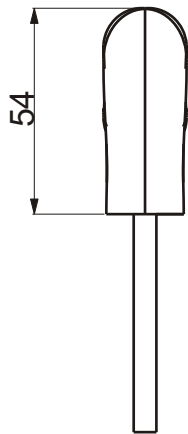

CORTE A-A

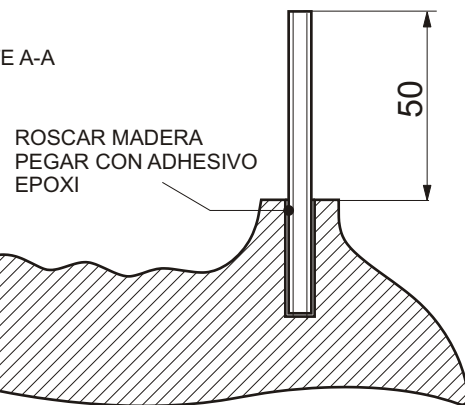

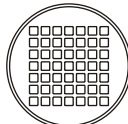
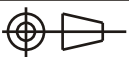
GUATAMBU ESP.: 3 MM CORTE AGUJEREADO ROSCADO PEGADO(epoxi)		FECHA	NOMBRE	BASTON	 INTI-INET CANTIDAD: 1 BT-04 01
	DIBUJO	2007			
	REVISO				
	APROBO				
	ESC. 1:2	MANGO DE MADERA			
					
TOLERANCIA					





EXPLOTADA COMPLETA

DESCRIPCION	CODIGO	CANTIDAD
MANGO MADERA GUATAMBU	BT-04 01	1
VIROLA	BT-02 01	1
PALO DE MADERA TORNEADO	BT-01 01	1
REGATON DE GOMA	BT-04 02	1

ACOTACIONES:**MANUAL DE ENSAMBLE**



COSTO UNITARIO STANDARD**BASTON**

PIEZA	MATERIAL	ESPECIFICACIÓN	UNIDAD DE COMPRA	\$ PRECIO UNITARIO	CANTIDAD	\$ VALOR TOTAL
VASTAGO	GUATAMBU	LARGO 1 MTR. DIAM 21 MM	POR VARILLA	\$ 3,30	1	\$ 3,30
REGATON	CAUCHO	LARGO = 45 MM DIÁM. INT = 21 MM	C/U	\$ 1,10	1	\$ 1,10
VIROLA	METAL	LARGO = 20 MM DIÁM. INT = 19 MM DIÁM. EXT = 21 MM	C/U	\$ 0,50	1	\$ 0,50
PROTECTOR	LUSTRE	1 LITRO	POR LITRO	\$ 21,00	1/14 BASTONES	\$ 1,50
					DESPERDICIO 10 %	\$ 6,40 \$ 0,64
					TOTAL	\$ 7,04

ACOTACIONES:

LOS VALORES SON CONSIDERADOS PARA UNA CANTIDAD DE 25 BASTONES

COSTOS

Instituto Nacional
de Tecnología Industrial

Sede Central
Avenida General Paz 5445
B1650KNA San Martín
Buenos Aires, Argentina
Teléfono (54 11) 4724 6200/300/400
discapacidad@inti.gov.ar
www.inti.gov.ar/discapacidad

Instituto Nacional
de Educación Tecnológica

Ministerio de Educación,
Ciencia y tecnología
Saavedra 789
C11229ACE, Buenos Aires
Argentina
Teléfono (54 11) 4129 2000